

# • 24mm F1.4 ED AS IF UMC Instruction Manual

Thank you for purchasing our lens. We believe that this new 24mm F1.4 ED AS IF UMC lens will give you a special photographic experience.

## Advantages of the 24mm F1.4 ED AS IF UMC

- 1.Ultra fast high-performance lens that correspond to a wide range.
- 2.Enables high resolution by using high-precision aspherical and Extra-low dispersion lenses.
- 3.Used of ultra-multi-coating (UMC) reduces flare and ghosting, it also delivers even greater image clarity.
- 4.8-blade diaphragm enables the lens to implement smooth out-focusing, it also implement dramatic bokeh effect as well.

This product is designed with its own mount. Hence, you can easily take photographs without installing an additional adaptor, mounting the lens directly onto the camera.

Read this instruction manual carefully and use it properly.

※ Please familiar yourself with the 'Safety Precautions' at the back of this instruction manual, and use the product according to them.

● Read this instruction manual prior to use. ●

## 1. Component Names

[Figure]

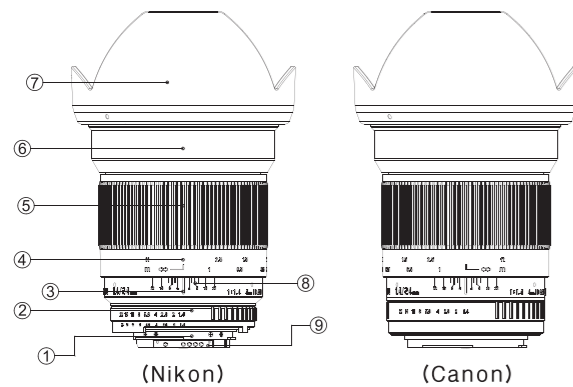

- ① Lens ring mount (camera locking area)
- ② Aperture value scale
- ③ Distance scale
- ④ Focus scaling ring
- ⑤ Hood locking tube
- ⑥ Focusing ring
- ⑦ Hood
- ⑧ Depth of field scale
- ⑨ CPU (Electronic contacts)

- AS: Aspherical lens (GAS: GAS, Glass Aspherical, HAS: Hybrid Aspherical)
- UMC: Ultra Multi-Coating
- ED(Extra-low Dispersion)
- IF (Inner Focus)

## 2. Attaching and Detaching to/from Camera

The 24mm F1.4 ED AS IF UMC lens mount is uniquely designed for Nikon (Fujifilm) F, Pentax (Samsung GX) K, Sony (Minolta) α, Canon EOS, Four-Thirds, and Samsung NX cameras.

### [Attaching]

1. Hold the hood of the lens gently.
2. Align the depth of field scale of the lens with the lens attachment reference point on the camera.
3. Push the lens into the camera and turn the lens gently until it makes a clicking sound and the depth of field scale is positioned at the top.
4. The Nikon mount is a lens (AE) in which a CPU is installed. Turn the aperture adjustment ring on the lens until it is set to the minimum aperture value (F22). (For the lens to be able to communicate with an AF camera, the aperture adjustment ring on the lens must be turned until F22, the F-number marked on the aperture adjustment ring, is aligned exactly with the depth of field scale on the lens.)

### [Detaching]

Hold the hood of the lens gently, press the lens release button on the camera, turn the lens until the depth of field scale of the lens is aligned with the lens attachment reference point on the camera, and then pull the lens away.

## 3. Focus Adjustment

You can set the focus for a subject by turning the focus adjustment ring when using the 24mm ED AS IF UMC lens, as it is a Manual Focus (MF) adjustment lens.

### [Nikon (Fujifilm) / Pentax (Samsung GX) Mount]

- ① To change the focus from a subject that is far away to a subject that is close, turn the focusing ring to the left (from ∞ to 0.25) and focus on the clearest subject using the camera's indication signal, or by checking visually.
- ② To change the focus from a subject that is close to a subject that is far away, turn the focusing ring to the right (from 0.25 to ∞) and focus on the clearest subject using the camera's indication signal, or by checking visually.

### [Canon/Canon M/ Fujifilm X/ Sony α/ Sony E/ FT/MFT/NX Mount]

- ① To change the focus from a subject that is far away to a subject that is close, turn the focusing ring to the left (from ∞ to 0.25) and focus on the clearest subject using the camera's indication signal, or by checking visually.
- ② To change the focus from a subject that is close to a subject that is far away, turn the focusing ring to the right (from 0.25 to ∞) and focus on the clearest subject using the camera's indication signal, or by checking visually.

## 4. Brightness Control

[Nikon (Fujifilm) F Mount]

1. AF camera (Applicable for both a film body and a digital body)
  - ① Brightness control in A mode (Aperture Priority mode)  
Turn the sub command dial at the front of the camera to adjust the brightness.
  - ② Brightness control in S mode (Shutter Speed Priority mode)  
Turn the main command dial at the back of the camera. The shutter speed is changed and the brightness is adjusted according to the changed shutter speed.
  - ③ Brightness control in P mode (Program mode)  
Turn the main command dial at the back of the camera to adjust the shutter speed and the brightness.
  - ④ Brightness control in M mode  
Turn the sub command dial at the front of the camera to adjust the brightness.

(The procedure and description above are given based on the D300. The camera settings are different depending on each model and are subject to change due to functional enhancements. Therefore, for detailed information on your camera settings, please refer to your camera manual or contact your camera manufacturer.)

2. Camera without contacts (Non-AF camera)

- ① Turn the aperture adjustment ring to set the brightness you want. The user can set the brightness he/she wants by turning the aperture adjustment ring when using the lens.

### [Canon/Canon M/ Fujifilm X/ Sony α/ Sony E/ FT/MFT/NX Mount]

- ① Turn the aperture adjustment ring to set the brightness you want. The user can set the brightness he/she wants by turning the aperture adjustment ring when using the lens.

### [Aperture adjustment ring markings]

- ① Canon/ Canon M/ Fujifilm X/ Nikon(fujifilm) F/ Samsung NX/ Sony α/ Sony E/ FT /MFT Mount

22	16	11	8	5.6	4	2.8	2	1.4
----	----	----	---	-----	---	-----	---	-----

- ② Pentax(Samsung GX) K

A · 22	16	11	8	5.6	4	2.8	2	1.4
--------	----	----	---	-----	---	-----	---	-----

Each number is 1 stop (1 EV) away from the next number. Brightness can be set more precisely by using the stop setting in-between. (However, the Sony (Minolta) mount is only controlled in steps of 1 stop.)

Example)

1.4 and 2 are 1 stop (1 EV) away from each other.

22	16	11	8	5.6	4	2.8	2	1.4
----	----	----	---	-----	---	-----	---	-----

Set the brightness between 2 and 1.4, which is 0.5 of a stop (0.5 EV) between the two.

22	16	11	8	5.6	4	2.8	2	1.4
----	----	----	---	-----	---	-----	---	-----

## 5. Mounting the Hood

The hood has a bayonet system, which guarantees speedy, efficient, safe and precise installation and facilitates the enjoyment of shooting that is free from ghosting or flaring.

[Figure]

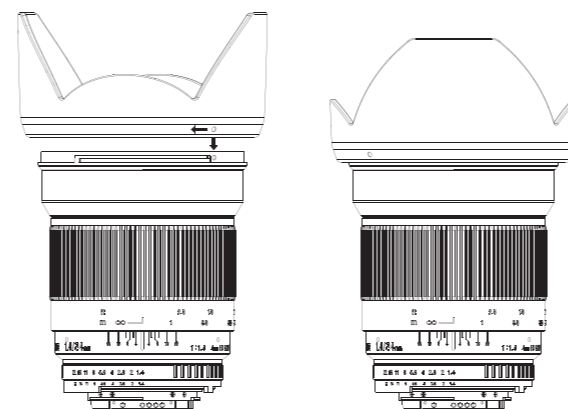

Align the attachment reference point on the hood with the reference point on the lens, push the hood onto the lens and turn the hood to the right until it makes a clicking sound.

## 6. About Photography

The aperture of the 24mm F1.4 ED AS IF UMC lens supports a maximum brightness of F1.4.

If you take a photo outdoors exposed to sunlight, you may not get a clear image because the subject is too bright. Therefore, adjust the brightness to an appropriate level and then take the photo. Since the depth of field becomes very shallow at F1.4, if the subject is not focused correctly you may get an unclear image. Therefore, to get a clear image, focus the subject correctly and then take the photo.

## 7. Camera Settings

Some cameras require special settings when using this lens. Please read the information below and set your camera accordingly.

### ○ Canon Mount

The diaphragm of the 24mm F1.4 ED AS IF UMC Canon mount is not compatible with the camera.

If the brightness is set to F8 or above, you may not be able to set the correct focus due to a difficulty in viewing the subject through the camera viewfinder. Turn the aperture adjustment ring so it is fully open when attaching the lens to the camera, and then set the depth of field and brightness you want prior to shooting.

- 1) Set the camera mode dial to M.

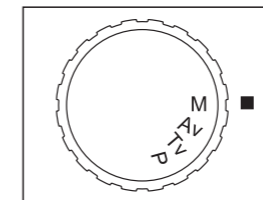

- 2) Adjust the shutter speed by turning the dial to achieve the appropriate exposure for the brightness.

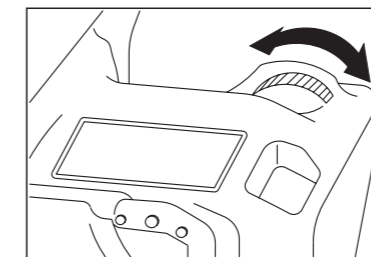

※ For some Canon cameras, if you set the camera mode dial to Av and set the brightness by turning the aperture adjustment ring on the lens, the camera automatically changes the shutter speed. Therefore you don't need to adjust the shutter speed as well, which is required in M mode.

(The procedures above are for the 40D. The settings for the camera or the menu may vary based on the camera model or due to a functional upgrade. Refer to the camera instruction manual or contact the camera manufacturer for detailed information.)

### ○ Nikon (Fujifilm) AE Mount

Your Nikon mount has electronic contacts that allow it to communicate with Nikon AF cameras. These contacts enable the A, S, and P modes of the camera. When a subject is correctly in focus, the camera emits a beep or an indicator light comes on.

### ○ Nikon (Fujifilm) F Mount

1. Set the camera mode dial to M.

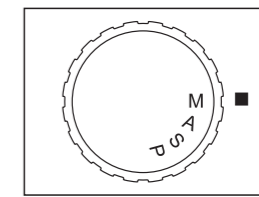

2. Set the focus adjustment lever of the camera to M.

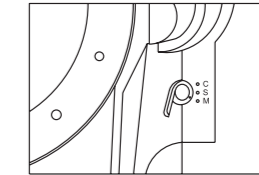

3. When an MF lens is attached, some Nikon cameras allow you to enter the focal length and the brightness. With these Nikon cameras, you can use the MF lens more efficiently by entering the focal length and the brightness.

※ The shutter speed of some Nikon cameras changes automatically if the focal length and the brightness are set, and the desired brightness is set in A/S/P mode by turning the aperture adjustment ring.

(The settings for the camera or the menu may vary based on the camera model or due to a menu upgrade. Refer to the camera manual or contact the camera manufacturer for detailed information.)

### ○ Pentax (Samsung GX) K Mount

1. AV mode (Aperture Priority Mode)  
The 24mm F1.4 ED AS IF UMC Pentax / Samsung mounts support Av mode.

- 1) Align the A mode indicator with the distance scale indicator mark by pressing the A button on the aperture adjustment ring of the lens.

- 2) Set the mode dial of the camera to Av.

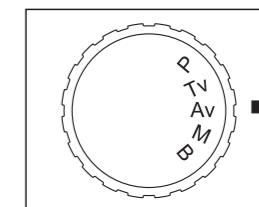

- 3) Set the focus adjustment lever of the camera to MF.

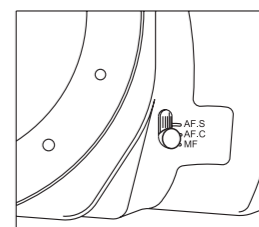

- 4) Camera Settings  
The user sets the menu. ⇒ The aperture ring is used. ⇒ Not allowed

- 5) Adjust the brightness by turning the dial at the back of the camera.

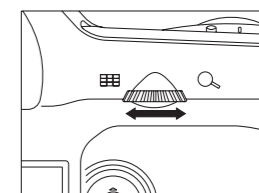

(The procedures above are for the K20D. The settings for the camera or the menu may vary based on the model or due to a functional upgrade. Refer to the camera instruction manual or contact the camera manufacturer for detailed information.)

### ○ Sony (Minolta) α Mount

The diaphragm of the 24mm F1.4 ED AS IF UMC Sony (Minolta) α mount is not compatible with the camera.

If the brightness is set to F8 or above, you may not be able to set the correct focus due to a difficulty in viewing the subject through the camera viewfinder. Turn the aperture adjustment ring so it is fully open when attaching the lens to the camera, and then set the depth of field and brightness you want prior to shooting.

- 1) Set the camera mode dial to M.

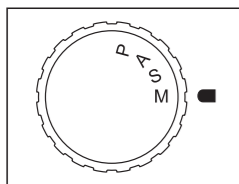

- 2) Set the focus adjustment lever of the camera to MF.

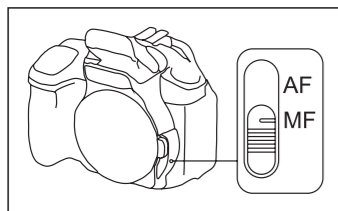

- 3) Adjust the shutter speed to achieve the appropriate exposure for the brightness.

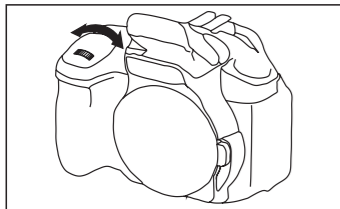

(The procedures above are for the α350. The settings for the camera or the menu may vary based on the model or due to a functional upgrade. Refer to the camera instruction manual or contact the camera manufacturer for detailed information.)

### ○ Konica Minolta (Minolta), DYNA series cameras

If this lens is used on some Konica Minolta (Minolta) or DYNA series cameras, the release lock function (misuse prevention function) of the camera must be disabled. It is required to disable the release lock function only on the first use as below.

Procedure for disabling the release lock function

- ① Set the main switch of the camera to OFF.
- ② Detach the lens from the camera body and set the main switch of the camera to ON by pressing the following two buttons.

- |   |  |
|---|--|
| 9xi ... function button + AE lock button              | 303si ... AV button + self mode button                                 |
| 7xi ... function button + AE lock button              | 303si SUPER ... drive button + spot button                             |
| 5xi ... function button + spot button                 | 101si ... self-timer button + flash button                             |
| 3xi ... Modification is required at a service center. | 360si ... self-timer continuous shooting button + screen select button |

- |   |   |
|---|---|
| 807si ... AEL button + shooting scene select button | α-Sweet ... self-timer continuous shooting button + spot button                   |
| 707si ... card button + spot button                 | α-Sweet S ... (set the function dial to multi light exposure)                     |
| 507si ... lens exchange button + ISO lock button    | P button + self-timer button  |
| DYNAX3L ... shooting scene select button + button   | DYNAX30 ... self-timer button + turn the left dial on the main body away from OFF |

α-Sweet II, II L ... Set the camera to custom function 14 and change the selection number from 1 to 2 (N.A.).

α-7, -9, -Ti ... Set the camera to custom function 16 and change the selection number from 1 to 2 (N.A.).

α-Sweet Digital ... Execute the following operation.

MENU ⇒ \*2 ⇒ Release lock without the lens ⇒ To the right ⇒ N.A. ⇒ Execute ● ⇒ MENU

α-7 Digital ... Execute the following operation.

MENU ⇒ \*3 ⇒ Release lock without the lens ⇒ To the right ⇒ N.A. ⇒ Execute ● ⇒ MENU

\* If the release lock is disengaged in the above way, the state of disengagement is maintained even though the main switch is turned off. If you want to enable the release lock function, perform the above procedure again.

(The settings for the camera or the menu may vary based on the camera model or due to a functional upgrade. Refer to the camera instruction manual or contact the camera manufacturer for detailed information.)

### ○ Mirrorless Cameras (Canon M, Samsung NX, Sony E, Fujifilm X)

The diaphragm of the 24mm F1.4 ED AS IF UMC Canon M, Samsung NX, Sony E and Fujifilm X mounts are not compatible with the cameras. If the brightness is set to F8 or above, you may not be able to set the correct focus due to a difficulty in viewing the subject through the camera viewfinder. Turn the aperture adjustment ring so it is fully open when attaching the lens to the camera, and then set the depth of field and brightness you want prior to shooting.

#### [ Canon M Mount ]

- 1) Set the exposure to manual exposure (M) and change the focus mode to MF.

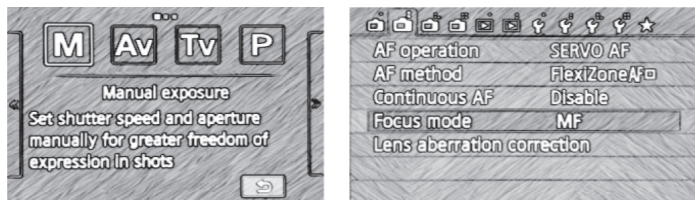

(The procedures above are for the Canon M. The settings for the camera or the menu may vary based on the camera model or due to a functional upgrade. Refer to the camera instruction manual or contact the camera manufacturer for detailed information.)

#### [ FUJIFILM X Mount ]

- 1) Set the focus mode to M.

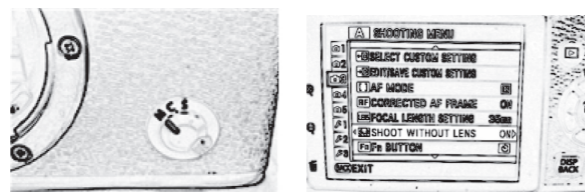

- 2) Press the MENU/OK button, and select ON at 'Shoot without lens' in the shooting menu.

(The procedures above are for the X-Pro1. The settings for the camera or the menu may vary based on the camera model or due to a functional upgrade. Refer to the camera instruction manual or contact the camera manufacturer for detailed information.)

#### [ Samsung NX Mount ]

- 1) Set the camera mode dial to M.
- 2) Adjust the shutter speed by turning the dial to achieve the appropriate exposure for the brightness.

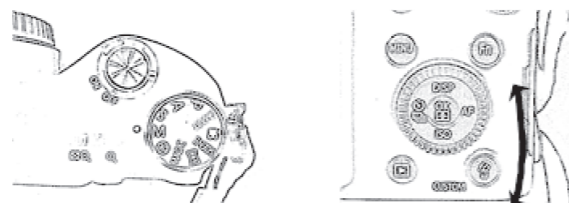

\* For some Samsung NX cameras, if you set the camera mode dial to A and set the brightness by turning the aperture adjustment ring on the lens, the camera automatically changes the shutter speed. Therefore you don't need to adjust the shutter speed as well, which is required in M mode.

(The procedures above are for the NX200. The settings for the camera or the menu may vary based on the camera model or due to a functional upgrade. Refer to the camera manual or contact the camera manufacturer for detailed information.)

#### [ Sony E Mount ]

- 1) Set the camera mode dial to M.
- 2) Adjust the shutter speed by turning the dial to achieve the appropriate exposure for the brightness.

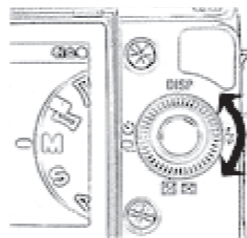

\* For some Sony E cameras, if you set the camera mode dial to A and set the brightness by turning the aperture adjustment ring on the lens, the camera automatically changes the shutter speed. Therefore you don't need to adjust the shutter speed as well, which is required in M mode.

(The procedures above are for the NEX-5. The settings for the camera or the menu may vary based on the model or due to a functional upgrade. Refer to the camera manual or contact the camera manufacturer for detailed information.)

### ○ Four Thirds, Micro Four Thirds

The diaphragm of the 24mm F1.4 ED AS IF UMC Four Thirds and Micro Four Thirds mounts are not compatible with the camera. If the brightness is set to F8 or above, you may not be able to set the correct focus due to a difficulty in viewing the subject through the camera viewfinder. Turn the aperture adjustment ring so it is fully open when attaching the lens to the camera, and then set the depth of field and brightness you want prior to shooting.

#### [ Four Thirds Mount ]

- 1) Hold down the MODE button and turn the dial until it is set to M. (shooting conditions) MODE + control dial ► M mode setting (manual shooting)

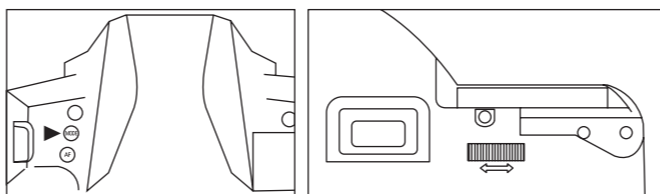

- 2) Hold down the AF button and turn the dial until it is set to MF. (focusing) AF + control dial ► MF setting (manual focusing)

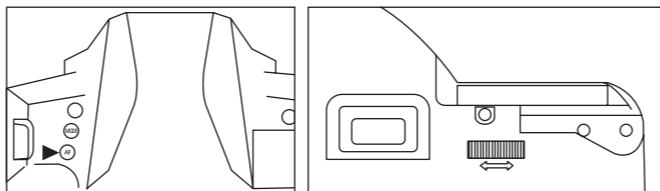

- 3) Adjust the shutter speed by turning the dial to achieve the appropriate exposure for the brightness.

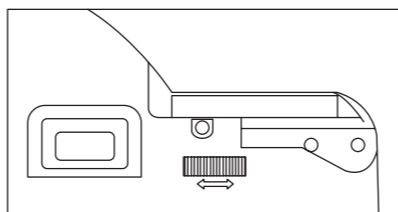

\* For some Four Thirds cameras, if you set the camera mode dial to A and set the brightness by turning the aperture adjustment ring on the lens, the camera automatically changes the shutter speed. Therefore you don't need to adjust the shutter speed as well, which is required in M mode.

(The procedures above are for the Olympus E-3. The settings for the camera or the menu may vary based on the camera model or due to a functional upgrade. Refer to the camera manual or contact the camera manufacturer for detailed information.)

#### [ Micro Four Thirds Mount ]

- 1) Set the camera mode dial to M.

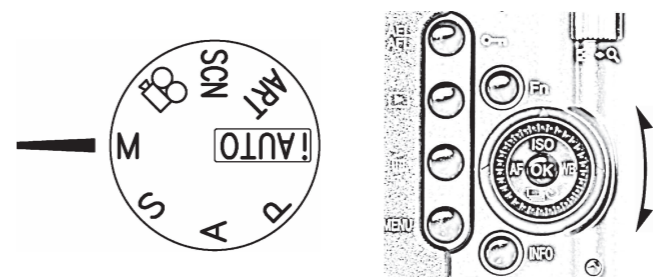

- 2) Adjust the shutter speed by turning the dial to achieve the appropriate exposure for the brightness.

\* For some Olympus (MFT) and Panasonic (MFT) cameras, if you set the camera mode dial to A and set the brightness by turning the aperture adjustment ring on the lens, the camera automatically changes the shutter speed. Therefore you don't need to adjust the shutter speed as well, which is required in M mode.

(The procedures above are for the E-P2. The settings for the camera or the menu may vary based on the camera model or due to a functional upgrade. Therefore refer to the camera manual or contact the camera manufacturer for detailed information.)

## 8. Specifications

SPECIFICATIONS		1:1.4 24mm ED AS IF UMC										
APERTURE RANGE		F1.4 ~ 22										
OPTICAL CONSTRUCTION		13 ELEMENTS IN 12 GROUPS (2 ASPHERICAL LENS)										
MINIMUM FOCUSING DISTANCE		0.25m(0.82ft)										
FILTER SIZE		ø 77mm										
MAXIMUM DIAMETER		ø 83mm										
MOUNT		CANON EOS	NIKON AE	PENTAX K	SONY α	CANON M	FUJIFILM X	SAMSUNG NX	SONY E	FOUR-THIRDS	MICRO FOUR-THIRDS	
ANGLE OF VIEW		35mm	84.1°	84.1°	84.1°	84.1°	-	-	-	84.1°	-	-
		APS-C	57.6°	61.8°	61.8°	61.8°	57.6°	61.8°	61.8°	61.8°	-	-
		FOUR-THIRDS 4/3"	-	-	-	-	-	-	-	47.6°	47.6°	
LENGTH		97.5mm	95mm	96mm	97mm	123.4mm	123.8mm	116mm	123.5mm	102.8mm	122.3mm	
WEIGHT		580g	565g	570g	575g	590g	630g	580g	590g	595g	585g	
FUNCTION		A / S / M / P mode(NIKON AE)										

## 9. Troubleshooting

Symptom	Cause	Action
I cannot attach the lens to my camera.	The reference point on the lens is not aligned with the lens attachment reference point on the camera.	Align the reference point on the lens with the lens attachment reference point on the camera.
I cannot detach the lens from my camera.	Incorrect rotation direction for detaching the lens. If you turn the lens while holding the camera, it may cause damage to the lens.	Hold down the lens release button on the camera, gently turn the lens toward the lens attachment/detachment reference point marked on the camera, and then pull the lens away.
Dark image	Incorrect focusing. Shutter speed insufficient, or camera shake.	Turn the focusing ring while checking the subject with the indicator in the camera or checking visually to set the focus until the subject is clear, and then press the shutter. Steady the camera and take a photograph at a shutter speed of 1/125 sec.
FEE (Blinking)	The aperture adjustment ring on the lens is not set to the minimum aperture value.	Turn the aperture adjustment ring to set it to the minimum aperture value (F22).
Autofocus failure	Autofocus failed with a manual control focus lens.	Set the focus by turning the focusing ring.
Pictures too dark or too bright	Inappropriate exposure	Adjust the aperture size.
The camera flash is not geared to the camera.	With a non-CPU lens, the camera flash may not be geared to some cameras.	See the camera manual.
	This lens corresponds to the Nikon AI-P lens.	See the camera manual or the flash manual. This lens is not a "D-type" lens (which relays distance information to the camera).
There is no camera finder indication or there is no display.	This lens doesn't have electronic contacts, so there is no electronic communication with the camera.	This does not indicate that there is a problem with shooting.
Zoom failure	This lens is a single lens.	
The lens can't be attached to other cameras.	This lens is designed for a specific mount.	Purchase the required lens mount.
	Our converter is designed for the T (M42 screw) mount only. Therefore, it cannot be used with the 24mm F1.4 ED AS IF UMC lens.	Use the appropriate company's own mount converter. However, be aware that autofocus adjustment will not be available.

## 10. Safety Precautions

The following precautions are divided into two types according to the level of danger.

**⚠ WARNING**  
If this instruction is not followed, it may cause death or severe injury to the user.

**⚠ CAUTION**  
If this instruction is not followed, it may cause death or severe injury to the user.

#### ⚠ WARNING

Don't look at the sun through the lens. It may cause blindness.



Don't leave the lens within reach of babies, as it may cause injury to the baby if the lens falls or is dropped.



#### ⚠ CAUTION

Attach the lens to the camera correctly and ensure the lens is held in place properly, otherwise the lens may not be removable, or may become loose and cause an accident.

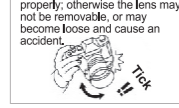

Don't attempt to modify or alter the lens. It may lead to failure of the camera. Modified or altered lenses may not be repaired.



Don't put excessive pressure on the lens attached to the camera, otherwise it may cause damage to the lens or to the camera mount. Be sure to hold the lens when operating or moving.

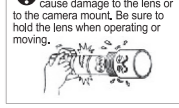

Don't leave the lens in direct sunlight. It may cause a fire, depending on lenses that concentrate light on a close object.

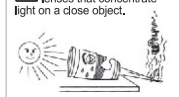

Ensure that the camera operates properly by checking the lens beforehand or by test shooting for important events such as a wedding ceremony and an overseas trip.



Don't look at the sun directly through a camera with a lens attached. It may cause damage to one's eyesight.



#### WARNING!

Don't get this product wet or expose it to a moist environment. It may cause a fire or electric shock.

#### CAUTION!

- Don't use this product or store it close to devices that generate heat, i.e., heaters, thermal regulators, stoves, stereo amplifiers.
- Don't leave the lens in conditions where drastic temperature changes can occur.
- Don't touch the surface of the lens by hand, and avoid making contact with sharp objects.
- Avoid dropping the lens.
- Don't let the lens get wet, and avoid water splashing onto the lens.
- If there are foreign bodies on the lens, use a lens cleaning kit only.